

RAZOR-BACK®

Secondary Belt Cleaner

Razor-Back® secondary belt cleaner features tough self-adjusting replaceable tungsten carbide blades (non-carbide also available) for extremely effective belt cleaning.

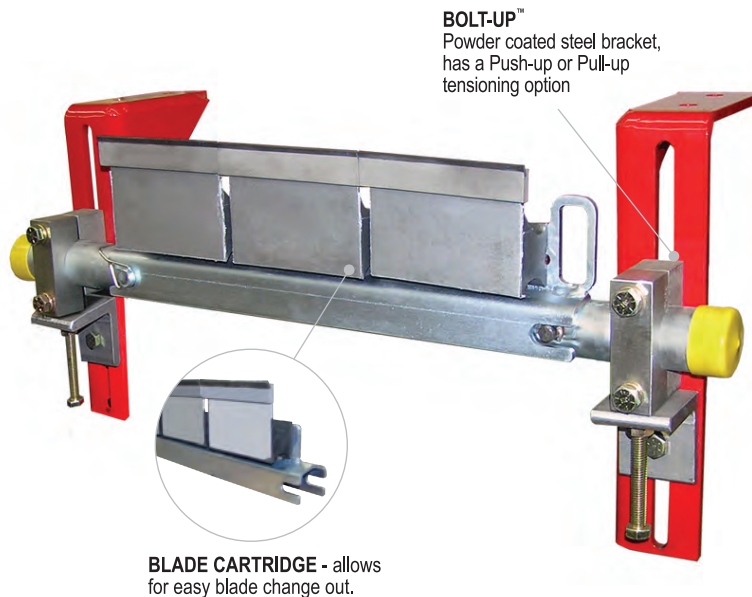

- **Longwearing Abrasion Resistant Blades** - available with replaceable V-Tips for vulcanized conveyor belts or C-Tips or F-Tips for conveyor belts with mechanical fasteners. Also available with Urethane and AR™ 400 blades.
- **Impact Absorbing Tension Cushions** - tension each individual blade to the belt for a controlled and effective belt cleaning across the entire width of the belt.
- **Compact Design** - allows for an installation that requires less than 9" of clearance to be installed and maintained.
- **Mechanical Splices? No Problem** - The Razor-Back® can be installed on belts with mechanical splices, due to the laid-back wiping blade angle and impact-absorbing tensioning cushions, allowing the mechanical splices to pass without damaging the belt cleaner or the splice.
- **Blade Cartridge** - allows for easy change out of scraper blades from either side of the conveyor
- **Available with** - Bolt-Up™, Duo-Spring™, or Spring-Shoc™ Tensioning Systems
- **Available with** - Optional Spray-Bar. Spray nozzle sizes can be customized for any desired spray pattern and water pressure.



PRODUCT SPECIFICATIONS

Maximum Belt Speed - 1000 fpm (5.0 m/sec)

Application - Coal Fired Power Plants, Hard Rock Mining, Steel Mills, Iron Ore, Aggregate and Mineral (Phosphate, Potash, Salt) Mining.

Need Solutions....to improve efficiency, safety and productivity? ask... ASGCO®

www.asgco.com | 800.344.4000



ASGCO®
Complete Conveyor Solutions

Spring-Shoc™ Secondary Tensioner

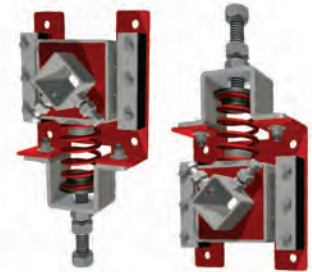
Utilizes a unique patent pending mounting plate that allows the cleaning blade to be spring tensioned in either a pull-up or push-up position. This specially designed configurability features two different mounting options that leave extra clearance above or below the bracket where necessary.



Push up or Pull-up tensioning options

Optional Tensioner: Bolt-Up™	Optional Tensioner: Duo-Spring™
 <ul style="list-style-type: none"> • Powder coated steel bracket • 304 stainless steel construction of adj. blocks • Lifetime Warranty 	 <ul style="list-style-type: none"> • All 304 stainless steel construction • Lifetime Warranty • Push-up or Pull-up tensioning options

Features

- Single spring tensioner for easy and consistent tensioner adjustments while maintaining constant cleaning pressure between the belt and the blade tips.
- Equal tensioning force in either tensioning configuration.
- Integrated dust shield keeps dust and fugitive material within the conveyor chute.
- Rugged construction for years of reliable cleaning.

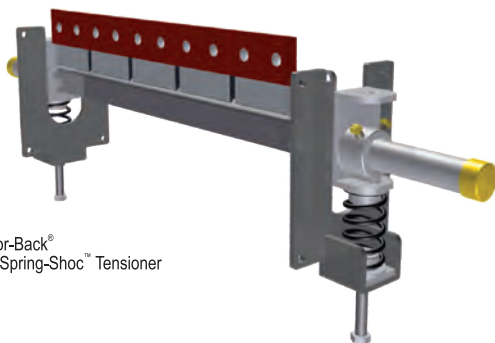

Razor-Back® with Spring-Shoc™ Tensioner





Razor-Back® with Spray Bar

Razor-Back® with Spray Bar is a secondary belt cleaner that uses a row of spray nozzles to spray a fine sharp stream of water at a 30° degree angle onto the conveyor belt where the carry-back material is difficult to remove. Water is applied to the belt in an overlapping spray pattern which places the particles into a fluid suspension, while moistening the belt. The blades of the Razor-Back® with Spray Bar are then able to make consistent contact with the conveyor belt surface to remove nearly 98% or more of bulk material coarse carry-back.

Features

- **Lubricate the conveyor** - belt/cleaners interface and require much lighter tensioning.
- **Fully adjustable sprays** - are built in enabling installation in the tightest of spaces.
- **Customized spray nozzle** - can be sized for any desired spray pattern and water pressure.
- **Tungsten carbide tips** - can be replaced which provides a long service life with a high level of resistance to impact damage and/or acid leaching.

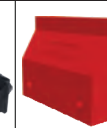
Available Blade Types

Razor-Back Blade Materials	F-Tips	C-Tips	V-Tips	U-Tip	XC-Tip
					
Blade Type	F-Tips	C-Tips	V-Tips	U-Tip	XC-Tip
Belt Speed	< 1000 fpm < 5 m/sec	< 1000 fpm < 5 m/sec	< 1000 fpm < 5 m/sec	< 1000 fpm < 5 m/sec	< 1400 fpm < 7 m/sec
Temperature Range	-20-400°F -28 to 204°C	-20-400°F -28 to 204°C	-20-400°F -28 to 204°C	-20-180°F -28 to 82°C	-20-400°F -28 to 204°C
Use w/Mech. Fasteners	Yes	Yes	Yes	Yes	Yes

Razor-Back® System

Part Number	Belt Width	
	in	mm
M-RBX-SYS-18-XX	18	450
M-RBX-SYS-24-XX	24	600
M-RBX-SYS-30-XX	30	750
M-RBX-SYS-36-XX	36	900
M-RBX-SYS-42-XX	42	1070
M-RBX-SYS-48-XX	48	1200
M-RBX-SYS-54-XX	54	1350
M-RBX-SYS-60-XX	60	1500
M-RBX-SYS-66-XX	66	1600
M-RBX-SYS-72-XX	72	1800
M-RBX-SYS-84-XX	84	2100

- X: AR (F-Tip)
- X: C-C (C-Tip)
- X: TC (V-Tip)
- X: CER (XC- Ceramic Blade)
- X: UB (Urethane Blade)

- XX: BU (Bolt-Up™ Tensioner)
- XX: RSS (Duo-Spring™ Tensioner)
- XX: ST (Spring-Shoc™ Tensioner)

Replacement Tips and Cushions

Part Number	Description
ASG-BLD-RZ-6-AR	F-Tip Blade
ASG-BLD-NW3-6-TC-C	C-Tip Blade
ASG-BLD-RZ-6-TC	V-Tip Blade
M-ASG-CUS-CER-6	XC-Ceramic
ASG-CUS-RZ-6C	Blade Cushion