

RAZOR-BACK MDX[®]

Secondary Belt Cleaner



Razor-Back MDX[®] is a secondary belt cleaner. It is designed for high speed and maximum tonnage mining systems running in the most aggressive underground and surface mining environments. The heavy-duty, replaceable, carbide-tipped blades effectively clean the conveyor belt with our dual action tensioning system to maintain even pressure across the entire belt surface.

Above & Underground Mine Duty Belt Cleaner!

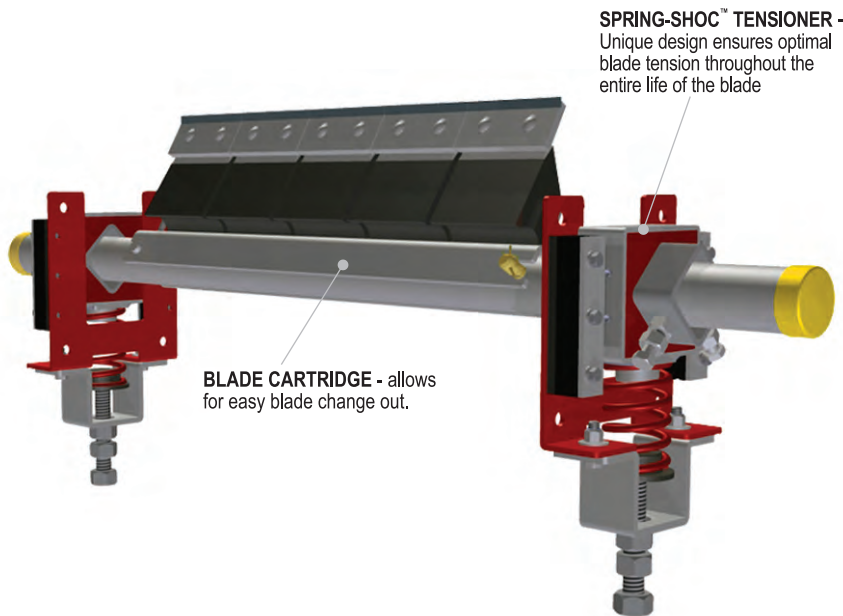

- **Complete Cleaning** - with our combination of cleaning blades specific for your application and dual tensioning action from our Spring-Shoc™ or Air-Shoc™ tensioner along with the impact absorbing rubber tensioning cushions and mounting system.
- **Available with replaceable MDX™ V-Tips** - for vulcanized conveyor belts or MDX™ C-Tips for conveyor belts with mechanical fasteners.
- **Quick-Change** - slide-out mounting system allows for simple removal of the cleaning cartridge from either side of the conveyor, without having to remove mounting brackets or the main mounting tube.
- **Designed** - for the toughest of mining environments and conditions including underground and surface coal, hard rock, power plant and load-out facilities.
- **Compatible and Safe** - for mechanically or vulcanized spliced conveyor belts and its slide-out blade cartridge allows for improve safety by avoiding workers having to crawl into confined chute areas or underneath conveyor structures.



PRODUCT SPECIFICATIONS

Maximum Belt Speed - 1200 fpm (6.0 m/sec)

Application - Underground Mining, Hard Rock Mining, Metals (copper/gold) Mining, Steel Mills, Iron Ore, Bulk Shipping Terminals, Coal Fired Power Plants

Need Solutions...to improve efficiency, safety and productivity? ask... ASGCO[®]

www.asgco.com | 800.344.4000





RAZOR-BACK MDX®

Spring-Shoc™ Secondary Tensioner

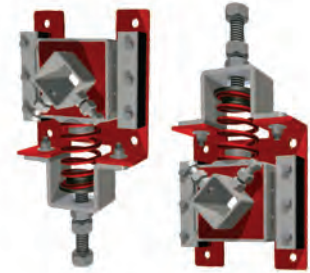
Utilizes a unique patent pending mounting plate that allows the cleaning blade to be spring tensioned in either a pull-up or push-up position. This specially designed configurability features two different mounting options that leave extra clearance above or below the bracket where necessary.







Push up or Pull-up tensioning options

Optional Tensioner: Bolt-Up™ MDX	Optional Tensioner: Air-Shoc MDX™
 <ul style="list-style-type: none"> • Powder coated steel bracket • 304 stainless steel construction of adj. blocks • Lifetime Warranty 	 <ul style="list-style-type: none"> • Zinc plated steel HD construction • Lifetime Warranty • UHMW slide bushings

Features

- Single spring tensioner for easy and consistent tensioner adjustments while maintaining constant cleaning pressure between the belt and the blade tips.
- Equal tensioning force in either tensioning configuration.
- Integrated dust shield keeps dust and fugitive material within the conveyor chute.
- Rugged construction for years of reliable cleaning.

Available Blade Types

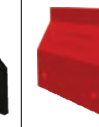
Razor-Back MDX Blade Materials					
Blade Type	XC-Tip	MDX F-Tips	MDX C-Tips	MDX V-Tips	U-Tip
Belt Speed	< 1400 fpm < 7 m/sec	< 1200 fpm < 6 m/sec	< 1200 fpm < 6 m/sec	< 1200 fpm < 6 m/sec	< 1000 fpm < 5 m/sec
Temperature Use w/Mech.	-20-400°F	-20-400°F	-20-400°F	-20-400°F	-20-82°C
Fasteners	No	Yes	Yes	No	Yes

Replacement Tips and Cushions

Part Number	Description	Lbs.
M-ASG-MDX-BLD-RZ-6-U	Urethane Blade	0
ASG-MDX-BLD-RZ-6-AR	MDX F-Tip	1
ASG-BLD-NW3-6-TC-C-MDX	MDX C-Tip	1
ASG-MDX-BLD-RZ-6-TC	MDX V-Tip	1
M-ASG-CUS-CER-6	XC Ceramic	1
ASG-CUS-RZ-6C-MDX	Blade Cushion	5

Razor-Back MDX® MDX System

Part Number	Belt Width		Wt. Lbs.
	in	mm	
M-RBXMDX-SYS-48-XX	48	1200	0
M-RBXMDX-SYS-54-XX	54	1350	0
M-RBXMDX-SYS-60-XX	60	1500	0
M-RBXMDX-SYS-72-XX	72	1800	0
M-RBXMDX-SYS-84-XX	84	2100	0
M-RBXMDX-SYS-96-XX	96	2400	0

X: TC-C (C-Tip)
X: TC (V-Tip)

XX: BU (Bolt-Up™ Tensioner)
XX: ST (Spring-Shoc™ Tensioner)
XX: AS (Air-Shoc™ Tensioner)

Need Solutions...to improve efficiency, safety and productivity? ask... ASGCO®

www.asgco.com | 800.344.4000

© 2024 ASGCO® "Complete Conveyor Solutions"

